

PRICE LIST
LISTINO PREZZI

2011



GIULIO BARBIERI
Special Modular Coverings



BROOKLYN

CANTILEVER SHELTER
COPERTURA A SBALZO

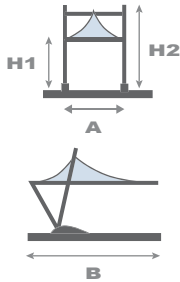

**SINGLE PEAK
UNA CUPOLA**

H1 = 240 cm H2 = 420 cm

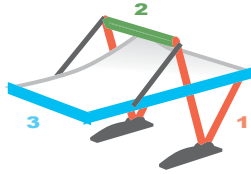
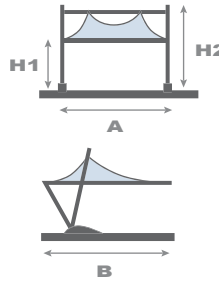
**TWO PEAKS
DUE CUPOLE**

H1 = 240 cm H2 = 420 cm

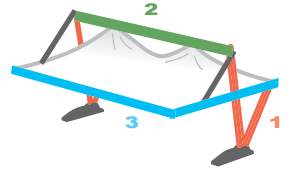

A (cm)	B (cm)	€	1	2	3	A (cm)	B (cm)	€	1	2	3
300	500	7686,00	M	M	P	600	500	9932,00	G	M	P
400	500	8024,00	M	M	P	700	500	12442,00	G	G	M
500	500	8338,00	M	M	P	800	500	12840,00	G	G	M
300	600	7882,00	M	M	P	600	600	10090,00	G	M	P
		8834,00	G	M	P	700	600	12679,00	G	G	M
400	600	8212,00	M	M	P	800	600	13106,00	G	G	M
		9163,00	G	M	P						
500	600	9505,00	G	M	P						

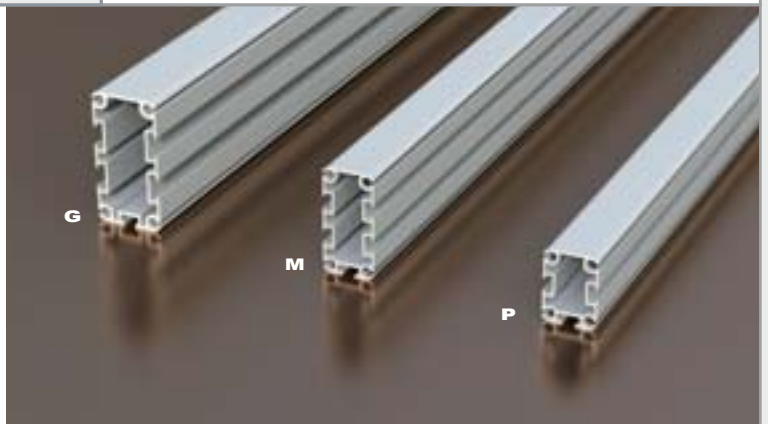
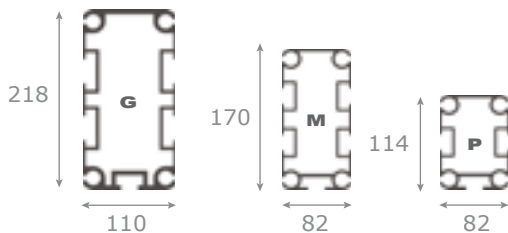
**TYPE OF PROFILES (mm)
MODELLI DEI PROFILI (mm)**

OPTIONALS FOR BROOKLYN OPTIONALS BROOKLYN

ANCHORING SYSTEMS SISTEMI DI ANCORAGGIO

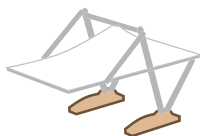

STANDARD

CONCRETE LOADS BASE DI SUPPORTO IN CEMENTO ARMATO

Kg. 620/each
Kg. 620 Cadauna

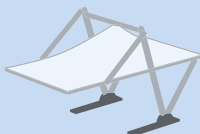

OPTIONAL+3%

ANCHORING PLATE complete with fixing steel pins to the ground.

PIASTRA
completa di staffe in
acciaio da tassellare a
pavimento.

EXTRA PRICE SOVRAPPREZZO

€ For two
pieces
A coppia

423,00

KIT FOR MODULES CONNECTION KIT UNIONE MODULI



SIDE LATO (cm)	€	SIDE LATO (cm)	€
300	102,00	600	141,00
400	114,00	700	259,00
500	127,00	800	259,00

CENTRAL JOINT GIUNTO CENTRALE



€ each
cad.

206,00

FRAME COLOUR COLORI DELLA STRUTTURA

STANDARD

Anodised silver colour
Anodizzato argento

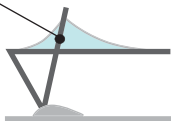

TOP COVER TELO DI COPERTURA

STANDARD



OPTIONAL +3%
BLACK-OUT
OSCURANTE

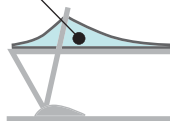

GABLE END TIMPANO

€ each
cad.

147,00





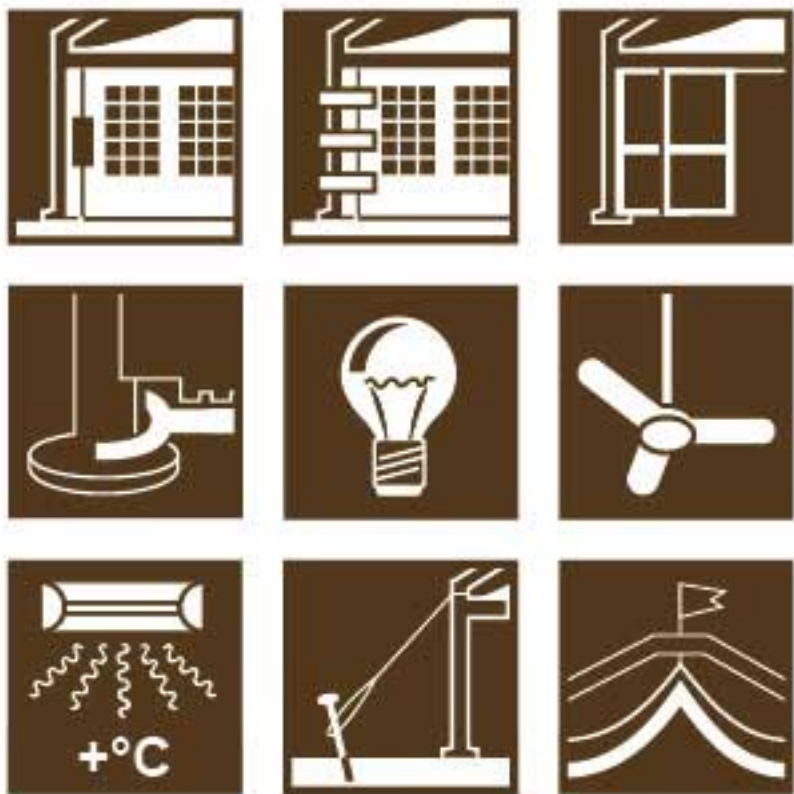

OPTIONALS
ACCESSORI





“ERMETICA” MODEL: RIGID SLIDING SIDE CLOSING

CHIUSURA SCORREVOLE RIGIDA MODELLO “ERMETICA”

“ERMETICA” RIGID SLIDING SIDE CLOSING

CHIUSURA PERIMETRALE RIGIDA “ERMETICA”

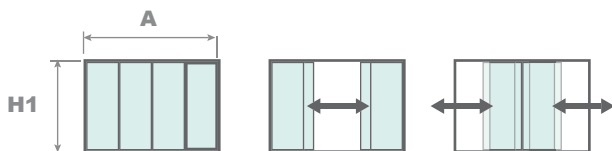

FRAME: made of aluminium powder coated (white colour, ral 9010).
SLIDING PANELS: made of safety glass or polycarbonate 10 mm.
TELAIO: in alluminio ral 9010.
PANNELLI: in vetro 3+3 stratificato o polycarbonato alveolare mm.10.

A (cm)	H1 (cm)	€	A (cm)	H1 (cm)	€
300	250	2310,00	430	250	2742,00
	300	2532,00		300	3004,00
350	250	2497,00	500	250	2943,00
	300	2686,00		300	3234,00
400	250	2571,00	600	250	3142,00
	300	2813,00		300	3450,00

FOR DIFFERENT TYPE OF PANEL: PER ALTRI TIPI DI PANNELLO:



STANDARD Ral 9010

OPTIONAL+7%

- Ral 9005
- Ral 1023
- Ral 6005
- Ral 5010
- Ral 3002

OTHER DIMENSIONS

ALTRE DIMENSIONI

A (cm)	NOTES FOR: NOTE PER:	Leader MULTI	Dynamic MULTI	A (cm)	NOTES FOR: NOTE PER:	Elite Elite Ln	A (cm)	NOTES FOR: NOTE PER:	FESTIVAL
700	n. 2 side walls 350 cm n. 2 pareti da cm. 350	800	800	800	n. 2 side walls 400 cm + n. 1 middle pole n. 2 pareti da cm. 400 + n. 1 montante intermedio	800	800	n. 2 side walls 400 cm + n. 1 telescopic pole kit n. 2 pareti da cm. 400 + n. 1 montante telescopico	
800	n. 2 side walls 400 cm n. 2 pareti da cm. 400				n. 2 side walls 500 cm n. 2 pareti da cm. 500			n. 2 side walls 500 cm n. 2 pareti da cm. 500	
1000	n. 3 side walls 400 cm n. 3 pareti da cm. 400	1300	1300	1300	n. 2 side walls 600 cm n. 2 pareti da cm. 600	1300	1300	n. 2 side walls 600 cm n. 2 pareti da cm. 600	
1200	n. 3 side walls 500 cm n. 3 pareti da cm. 500				n. 3 side walls 430 cm + n. 1 middle pole n. 3 pareti da cm. 430 + n. 1 montante intermedio			n. 2 side walls 500 cm n. 2 pareti da cm. 500	
1500	n. 3 side walls 600 cm n. 3 pareti da cm. 600								
1800									

MIDDLE POLE
MONTANTE INTERMEDIO



H1 (cm)	€
250	375,00
300	410,00

TELESCOPIC POLE KIT FOR:
MONTANTE TELESCOPICO PER:

FESTIVAL

H1 (cm)	€
250	108,00
300	117,00

OPENING DOOR
ANTA BATTENTE



€

ON REQUEST
A PREVENTIVO

OPTIONALS

"CLACK" MODEL: PVC SLIDING SIDE CLOSING
 CHIUSURA SCORREVOLE MODELLO "CLACK" IN TELO PVC



"CLACK" CLOSING FOR BROOKLYN
 CHIUSURA "CLACK" PER BROOKLYN

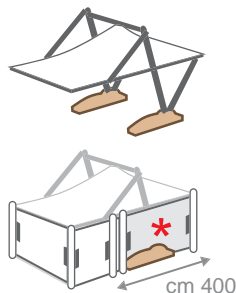

BROOKLYN WITH STANDARD ANCHORING SYSTEM (CONCRETE LOADS)
 BROOKLYN CON ANCORAGGIO STANDARD (BASI IN CEMENTO ARMATO)

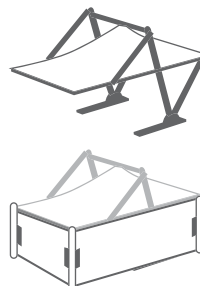

BROOKLYN WITH OPTIONAL ANCHORING SYSTEM (ANCHORING PLATES)
 BROOKLYN CON SISTEMA DI ANCORAGGIO OPZIONALE (PIASTRE)

cm 240			
	PLAIN WALL STANDARD	WINDOWS WALL FINESTRATA	ALUMINIUM GROUND GUIDE GUIDA A TERRA IN ALLUMINIO

* SIDE WALL PROPERLY SHAPED PARETE SAGOMATA

cm 400

Plain wall Standard

L (cm)	€	€	€
100	227,00	264,00	66,00
200	273,00	322,00	88,00
300	328,00	389,00	103,00
350	359,00	429,00	113,00
400	379,00	455,00	124,00
500	431,00	520,00	142,00
600	496,00	600,00	160,00

€ each cad.

425,00

cm 400

Windows wall Finestrata

€ each cad.

511,00

700	n. 2 side walls 350 cm + n. 1 curtain supporting pole n. 2 pareti da cm. 350 + n. 1 montante di sostegno
800	n. 2 side walls 400 cm + n. 1 curtain supporting pole n. 2 pareti da cm. 400 + n. 1 montante di sostegno

cm 240			
	PLAIN WALL STANDARD	WINDOWS WALL FINESTRATA	ALUMINIUM GROUND GUIDE GUIDA A TERRA IN ALLUMINIO

L (cm)	€	€	€
100	227,00	264,00	66,00
200	273,00	322,00	88,00
300	328,00	389,00	103,00
350	359,00	429,00	113,00
400	379,00	455,00	124,00
500	431,00	520,00	142,00
600	496,00	600,00	160,00

700	n. 2 side walls 350 cm + n. 1 curtain supporting pole n. 2 pareti da cm. 350 + n. 1 montante di sostegno
800	n. 2 side walls 400 cm + n. 1 curtain supporting pole n. 2 pareti da cm. 400 + n. 1 montante di sostegno

CURTAIN SUPPORTING POLE MONTANTI DI SOSTEGNO

€ each cad.

133,00

CURTAIN SUPPORTING POLE MONTANTI DI SOSTEGNO

€ each cad.

133,00

OPTIONALS



LIGHTING SYSTEM
SISTEMI DI ILLUMINAZIONE

ALUMINIUM ELECTRIC BAR
ASTA ELETTTRIFICATA IN ALLUMINIO

HALOGEN LIGHT
FARETTI ALOGENI

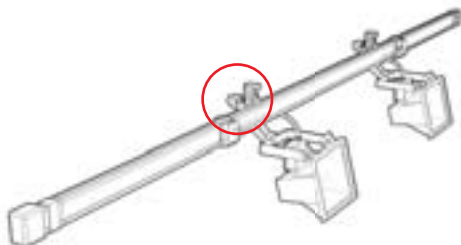

€ each cad.

230,00

NEON LIGHT
PLAFONIERA AL NEON

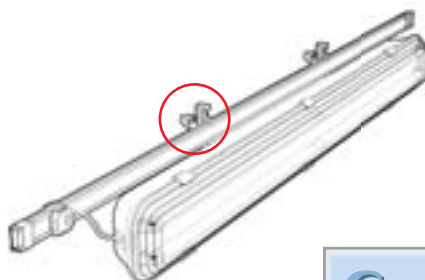

€ each cad.

230,00

LIGHT CONTROL
COMANDO LUCI



€ each cad.

239,00

CONNECTION CABLE
CAVO DI COLLEGAMENTO



LENGTH LUNGH. (cm)	€ each cad.	LENGTH LUNGH. (cm)	€ each cad.
400	88,00	1400	116,00
800	98,00	1800	127,00

LOW CONSUMPTION LAMPS
LAMPADIE A BASSO CONSUMO



€ each cad.

306,00

LIGHT CONTROL
COMANDO LUCI



€ each cad.

245,00

CONNECTION CABLE
CAVO DI COLLEGAMENTO



LENGTH LUNGH. (cm)	€ each cad.
600	87,00

**OPTIONAL
ADDITIONAL CABLE**
CAVO AGGIUNTIVO

€ /ml **2,00**

OPTIONALS

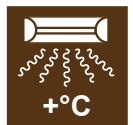

INFRARED RAYS HEATING
RISCALDATORE A RAGGI INFRAROSSI

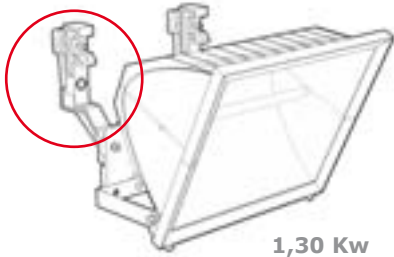

1,30 Kw

€ each
cad.

266,00

INFRARED RAYS HEATING
RISCALDATORE A RAGGI INFRAROSSI

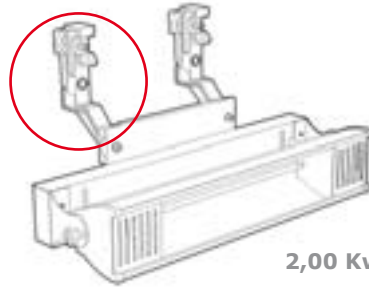

2,00 Kw

€ each
cad.

430,00



= **SLIDE-IN TYPE FASTENING SYSTEM**
= **SISTEMA AD AGGANCIAMENTO RAPIDO**

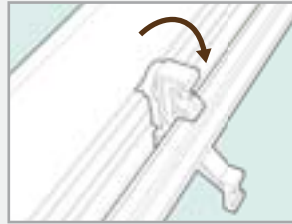

REFRESHING SYSTEM
SISTEMA DI VENTILAZIONE



OPTIONALS

THREE-BLADES FAN WITH CONTROL
VENTILATORE A TRE PALE CON COMANDO

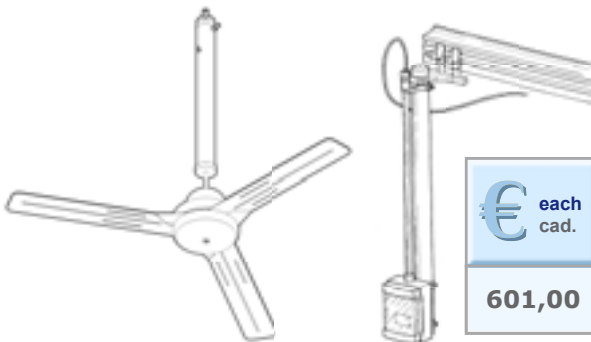

€ each
cad.

601,00

THREE-BLADES FAN WITH LAMP AND CONTROL
VENTILATORE A TRE PALE CON LUCE E COMANDO

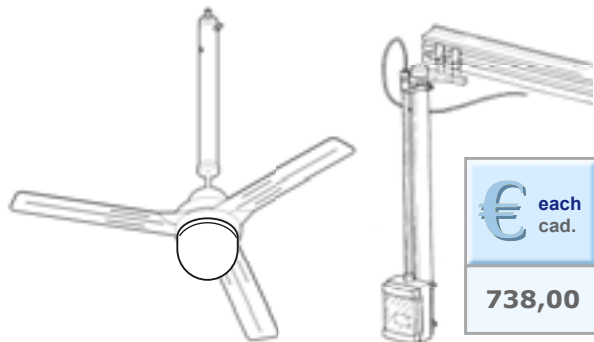

€ each
cad.

738,00



**AUXILIARY OPTIONALS FOR INSTALLATION
AND STORAGE**

**ACCESSORI AUSILIARI D'INSTALLAZIONE E
STOCCAGGIO**

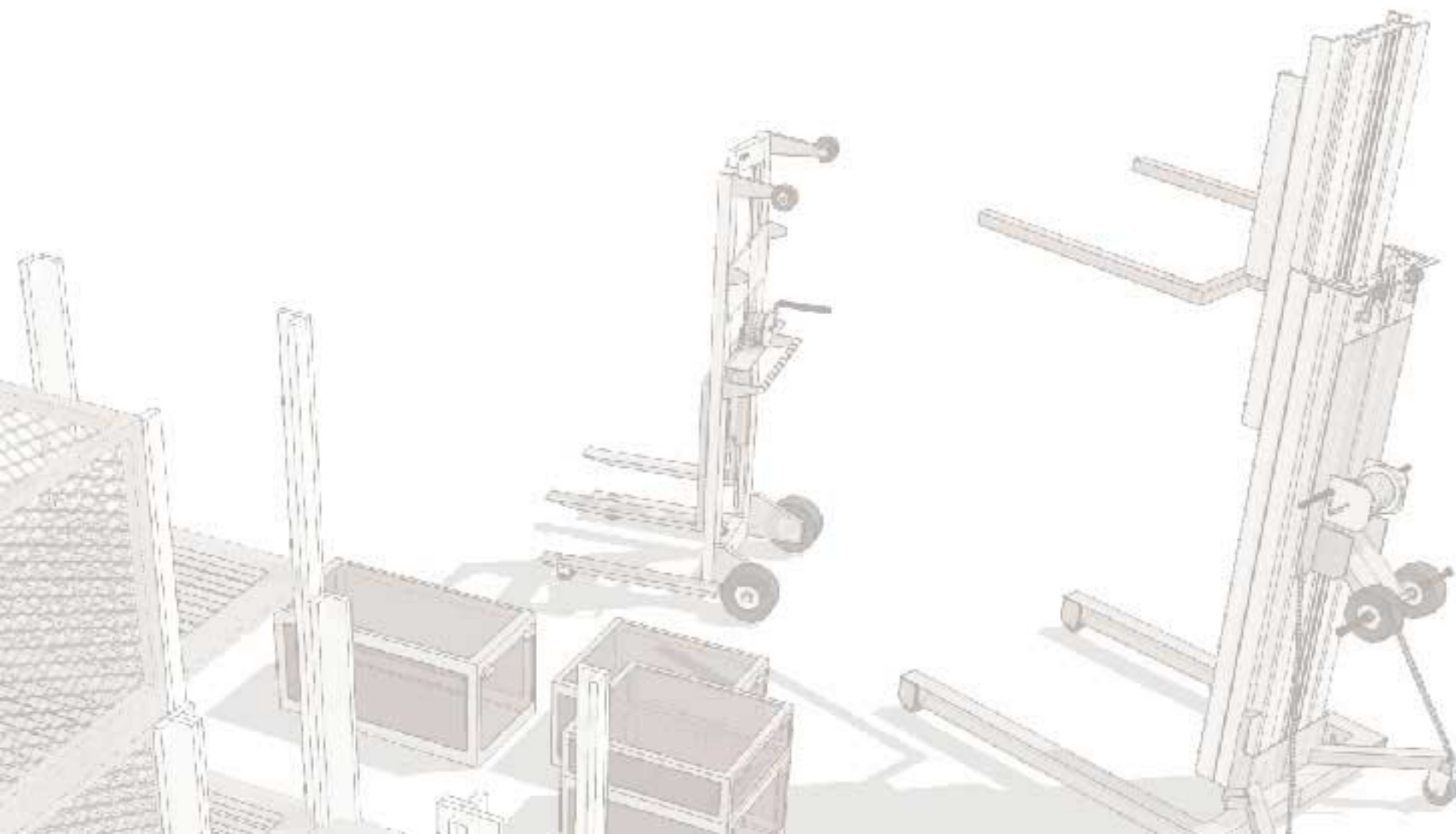



CERTIFIED LIFTING HOISTS
CARRELLI DI SOLLEVAMENTO OMOLOGATI

MODELS MODELLI			
LIFT	SLA 10	SLA 15	
<p>TENT PASS HEIGHT= 250 cm ALTEZZA UTILE GAZEBO= 250 cm</p> <p>SILVER</p> <p>Summer 4</p> <p>Leader 4</p> <p>Dynamic 4</p>	<p>TENT PASS HEIGHT= 250 cm ALTEZZA UTILE GAZEBO= 250 cm</p> <p>Leader 6 Dynamic 6</p> <p>Leader 8 Dynamic 8</p> <p>Leader MULTI Dynamic MULTI</p> <p>FESTIVAL</p> <p>Elite Elite Ln</p>	<p>TENT PASS HEIGHT= 300 cm ALTEZZA UTILE GAZEBO= 300 cm</p> <p>Leader 6 Dynamic 6</p> <p>Leader 8 Dynamic 8</p> <p>Leader MULTI Dynamic MULTI</p> <p>FESTIVAL MEETING</p> <p>Elite Elite Ln</p>	
	<p>H max = 300 cm</p>	<p>H max = 450 cm</p>	
	<p>Kg max. = 159 Kg</p>	<p>Kg max. = 454 Kg</p>	<p>Kg max. = 363 Kg</p>
	<p>€ each cad.</p> <p>2682,00</p>	<p>€ each cad.</p> <p>3836,00</p>	<p>€ each cad.</p> <p>4547,00</p>
	<p>LIFTING HOIST'S WEIGHT PESO DEL SOLLEVATORE</p>		
68 Kg	118 Kg	144 Kg	



“RACK” CONTAINERS
CONTENITORI “RACK”

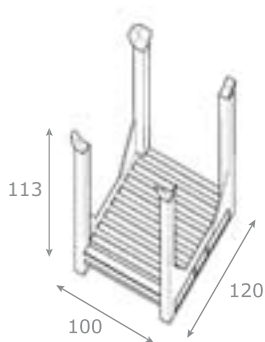

GREY
GRIGIO
RAL 7000

€ each
cad.

436,00

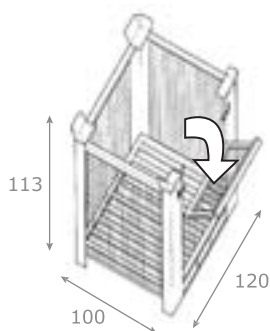

GREY
GRIGIO
RAL 7000

€ each
cad.

383,00

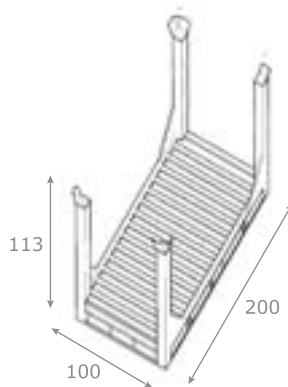

GREY
GRIGIO
RAL 7000

€ each
cad.

595,00

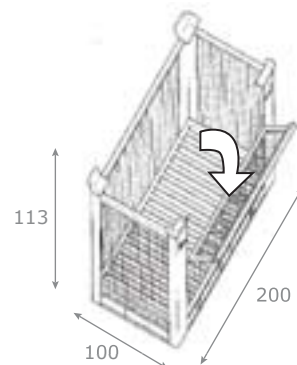

GREY
GRIGIO
RAL 7000

€ each
cad.

750,00