

PRICE LIST
LISTINO PREZZI

2011



GIULIO BARBIERI
Special Modular Coverings





NEW GENERATION TENTS
GAZEBO DI NUOVA GENERAZIONE



Leader

4

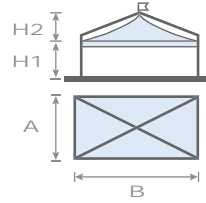
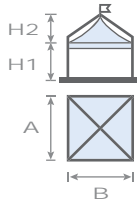

A=B (cm)	H1 (cm)	€	H2 (cm)	AREA (sqm) (mq)	A (cm)	B (cm)	H1 (cm)	€	H2 (cm)	AREA (sqm) (mq)
300	250	2292,00	150	9,0	300	400	250	2591,00	170	12,0
	300	2345,00					300	2645,00		
400	250	2621,00	190	16,0	300	500	250	2795,00	195	15,0
	300	2674,00					300	2848,00		
500	250	3073,00	230	25,0	300	600	250	3381,00	220	18,0
	300	3126,00					300	3434,00		
600	250	4014,00	270	36,0	400	500	250	3042,00	210	20,0
	300	4068,00					300	3095,00		
					400	600	250	3587,00	235	24,0
					500	600	250	3918,00	250	30,0
							300	3641,00		
							300	3971,00		

Leader

6

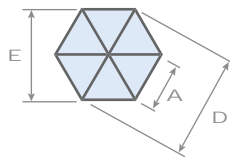
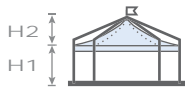

A (cm)	H1 (cm)	€	H2 (cm)	AREA (sqm) (mq)	D (cm)	E (cm)
300	250	4350,00	200	23,4	600	520
	300	4437,00				
400	250	4933,00	255	41,5	800	690
	300	5018,00				
500	250	6519,00	305	65,0	1000	865
	300	6606,00				

Leader

8

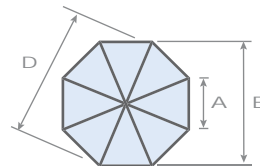

A (cm)	H1 (cm)	€	H2 (cm)	AREA (sqm) (mq)	D (cm)	E (cm)
300	250	6081,00	250	43,5	785	725
	300	6197,00				
400	250	7657,00	330	77,5	1045	965
	300	7773,00				

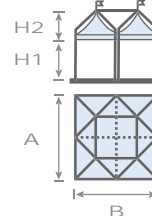
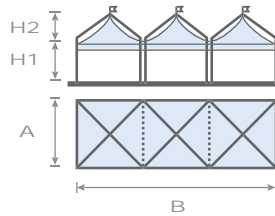
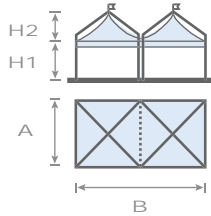

A (cm)	B (cm)	H1 (cm)	€	H2 (cm)	AREA (sqm) (mq)	A (cm)	B (cm)	H1 (cm)	€	H2 (cm)	AREA (sqm) (mq)	A=B (cm)	H1 (cm)	€	H2 (cm)	AREA (sqm) (mq)
300	600	250	4515,00	150	18,0	300	900	250	6736,00	150	27,0	700	250	7348,00	170	49,0
		300	4621,00					300	6896,00				300	7508,00		
400	800	250	5101,00	190	32,0	400	1200	250	7582,00	190	48,0					
		300	5208,00					300	7742,00							
500	1000	250	5943,00	230	50,0	500	1500	250	8815,00	230	75,0					
		300	6050,00					300	8975,00							
600	1200	250	7740,00	270	72,0	600	1800	250	11465,00	270	108,0					
		300	7846,00					300	11625,00							

 OPTIONS FOR DYNAMIC MODEL
 OPTIONS MODELLO DYNAMIC

 FRAME COLOURS
 COLORI DELLA STRUTTURA

 STANDARD Ral 9010

OPTIONAL+7%

- Ral 9005
- Ral 6005
- Ral 3002
- Ral 1023
- Ral 5010

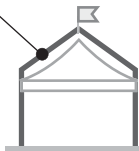
 TOP COVER AND VALANCES
 TELA DI COPERTURA E MANTOVANE

STANDARD

OPTIONAL+3%

OPTIONAL +3%
BLACK-OUT
OSCURANTE

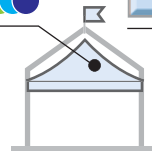

STANDARD

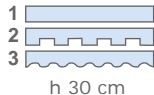
 JUNCTION FILLER
 COPRIFESSURA

H1 (cm)	€
250	30,00
300	36,00

 KIT FOR MODULES CONNECTION
 KIT UNIONE MODULI



SIDE LATO (cm)	€	SIDE LATO (cm)	€
300	102,00	600	141,00
400	114,00	700	259,00
500	127,00		

 CENTRAL JOINT
 GIUNTO CENTRALE

MODEL MODELLO	€ each cad.	MODEL MODELLO	€ each cad.
LEADER 4	206,00	LEADER 8	206,00
LEADER 6	206,00	LEADER MULTI	37,00

Dynamic

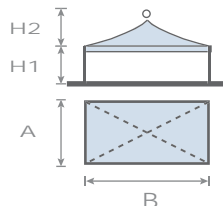
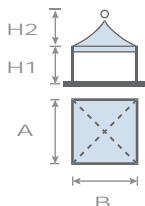
4



A=B (cm)	H1 (cm)	€	H2 (cm)	AREA (sqm) (mq)	A (cm)	B (cm)	H1 (cm)	€	H2 (cm)	AREA (sqm) (mq)
300	250	2350,00	130	9,0	300	400	250	2642,00	150	12,0
	300	2403,00					300	2695,00		
400	250	2687,00	170	16,0	300	500	250	2859,00	175	15,0
	300	2739,00					300	2913,00		
500	250	3116,00	210	25,0	300	600	250	3425,00	200	18,0
	300	3169,00					300	3478,00		
600	250	4100,00	250	36,0	400	500	250	3093,00	190	20,0
	300	4154,00					300	3146,00		
					400	600	250	3673,00	215	24,0
							300	3726,00		
					500	600	250	3946,00	230	30,0
							300	4000,00		

Dynamic

6

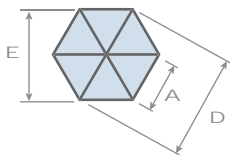

A (cm)	H1 (cm)	€	H2 (cm)	AREA (sqm) (mq)	D (cm)	E (cm)
300	250	4388,00	180	23,4	600	520
	300	4475,00				
400	250	4935,00	235	41,5	800	690
	300	5022,00				
500	250	6678,00	285	65,0	1000	865
	300	6765,00				

Dynamic

8

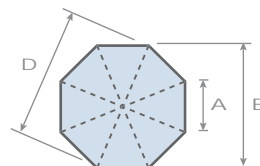

A (cm)	H1 (cm)	€	H2 (cm)	AREA (sqm) (mq)	D (cm)	E (cm)
300	250	6055,00	250	43,5	785	725
	300	6170,00				
400	250	7795,00	330	77,5	1045	965
	300	7911,00				

Dynamic MULTI

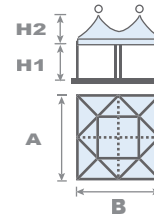
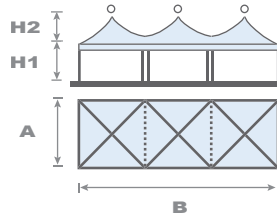
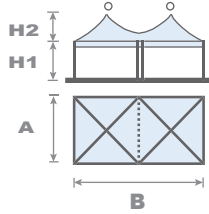

A (cm)	B (cm)	H1 (cm)	€	H2 (cm)	AREA (sqm) (mq)	A (cm)	B (cm)	H1 (cm)	€	H2 (cm)	AREA (sqm) (mq)	A=B (cm)	H1 (cm)	€	H2 (cm)	AREA (sqm) (mq)
300	600	250	4451,00	130	18,0	300	900	250	6552,00	130	27,0	700	250	7218,00	150	49,0
		300	4558,00					300	6713,00				300	7377,00		
400	800	250	5054,00	170	32,0	400	1200	250	7421,00	170	48,0					
		300	5161,00					300	7582,00							
500	1000	250	5851,00	210	50,0	500	1500	250	8588,00	210	75,0					
		300	5959,00					300	8748,00							
600	1200	250	7732,00	250	72,0	600	1800	250	11365,00	250	108,0					
		300	7839,00					300	11525,00							

OPTIONALS FOR DYNAMIC MODEL OPTIONALS MODELLO DYNAMIC

FRAME COLOURS COLORI DELLA STRUTTURA

STANDARD Ral 9010

- OPTIONAL+7%**
- Ral 9005
 - Ral 1023
 - Ral 6005
 - Ral 5010
 - Ral 3002

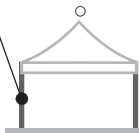

TOP COVER AND VALANCES TELO DI COPERTURA E MANTOVANE

STANDARD

OPTIONAL +3%
BLACK-OUT
OSCURANTE

OPTIONAL+3%

STANDARD

-
-
-

h 30 cm

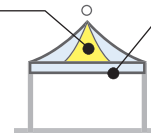
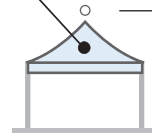

JUNCTION FILLER COPRIFESSURA

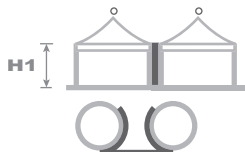

H1 (cm)	€
250	30,00
300	36,00

KIT FOR MODULES CONNECTION KIT UNIONE MODULI



SIDE LATO (cm)	€	SIDE LATO (cm)	€
300	102,00	600	141,00
400	114,00	700	259,00
500	127,00		

CENTRAL JOINT GIUNTO CENTRALE



MODEL MODELLO	€ each cad.	MODEL MODELLO	€ each cad.
LEADER 4	206,00	LEADER 8	206,00
LEADER 6	206,00	LEADER MULTI	37,00

A=B (cm)	H1 (cm)	€	H2 (cm)	AREA (sqm) (mq)	A=B (cm)	H1 (cm)	€	H2 (cm)	AREA (sqm) (mq)		
800	250	12567,00	185	64,0	1000	250	15635,00	226	100,0		
	300	12694,00				300	15918,00				
					1200	250	19706,00	270	144,0		
						300	19987,00				
					1300	250	22377,00	288	169,0		
						300	22658,00				
A (cm)	B (cm)	H1 (cm)	€	H2 (cm)	AREA (sqm) (mq)	A (cm)	B (cm)	H1 (cm)	€	H2 (cm)	AREA (sqm) (mq)
400	800	250	8356,00	185	32,0	500	1000	250	9833,00	226	50,0
		300	8481,00					300	10036,00		
						600	1200	250	11175,00	270	72,0
								300	11379,00		

OPTIONALS FOR ELITE MODEL
 OPTIONALS MODELLO ELITE

FRAME COLOURS
COLORI DELLA STRUTTURA

STANDARD Ral 9010

OPTIONAL + 7%

Ral 9005
 Ral 1023
 Ral 6005
 Ral 5010
 Ral 3002

TOP COVER AND VALANCES
TELO DI COPERTURA E MANTOVANE

STANDARD

OPTIONAL + 3%
BLACK-OUT
OSCURANTE

OPTIONAL + 3%

STANDARD

1

2

3

h 30 cm

JUNCTION FILLER
COPRIFESSURA

H1 (cm)	€
250	53,00
300	64,00

KIT FOR MODULES CONNECTION
KIT UNIONE MODULI

SIDE LATO (cm)	€	SIDE LATO (cm)	€
400	114,00	1000	284,00
500	127,00	1200	312,00
600	141,00	1300	322,00
800	259,00		

CENTRAL JOINT
GIUNTO CENTRALE

€

206,00

A=B (cm)	H1 (cm)	€	H2 (cm)	AREA (sqm) (mq)	A=B (cm)	H1 (cm)	€	H2 (cm)	AREA (sqm) (mq)		
800	250	13762,00	165	64,0	1000	250	16798,00	206	100,0		
	300	13887,00				300	17080,00				
					1200	250	21273,00	250	144,0		
						300	21556,00				
					1300	250	23722,00	268	169,0		
						300	24004,00				
A (cm)	B (cm)	H1 (cm)	€	H2 (cm)	AREA (sqm) (mq)	A (cm)	B (cm)	H1 (cm)	€	H2 (cm)	AREA (sqm) (mq)
400	800	250	8084,00	165	32,0	500	1000	250	9529,00	206	50,0
		300	8209,00					300	9733,00		
						600	1200	250	10943,00	250	72,0
								300	11148,00		

OPTIONALS FOR ELITE-IN MODEL
 OPTIONALS MODELLO ELITE-IN

FRAME COLOURS
COLORI DELLA STRUTTURA

STANDARD Ral 9010

OPTIONAL +7%

- Ral 9005
- Ral 6005
- Ral 3002
- Ral 1023
- Ral 5010

TOP COVER AND VALANCES
TELO DI COPERTURA E MANTOVANE

STANDARD

OPTIONAL +3%
BLACK-OUT
OSCURANTE

OPTIONAL +3%

STANDARD

1
2
3

h 30 cm

JUNCTION FILLER
COPRIFESSURA

H1

H1 (cm)	€
250	53,00
300	64,00

KIT FOR MODULES CONNECTION
KIT UNIONE MODULI

SIDE LATO (cm)	€	SIDE LATO (cm)	€
400	114,00	1000	284,00
500	127,00	1200	312,00
600	141,00	1300	322,00
800	259,00		

CENTRAL JOINT
GIUNTO CENTRALE

€

206,00

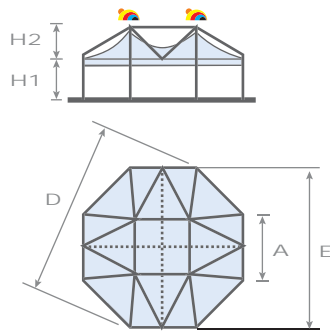





A (cm)	H1 (cm)	€	H2 (cm)	AREA (sqm) (mq)	D (cm)	E (cm)
500	250	24837,00	280	120,0	1305	1205
	300	25079,00				
600	250	27348,00	330	174,0	1570	1450
	300	27590,00				

OPTIONALS FOR MEETING MODEL
OPTIONALS MODELLO MEETING

FRAME COLOURS
COLORI DELLA STRUTTURA

STANDARD  Ral 9010

OPTIONAL + 7%

 Ral 9005  Ral 1023
 Ral 6005  Ral 5010
 Ral 3002



TOP COVER AND VALANCES
TELO DI COPERTURA E MANTOVANE



STANDARD 

OPTIONAL + 3%
BLACK-OUT
OSCURANTE

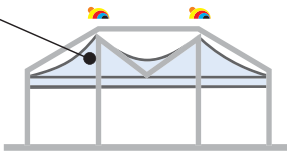
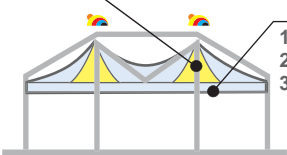
OPTIONAL + 3%





STANDARD

- 1 
- 2 
- 3 

h 30 cm

JUNCTION FILLER
COPRIFESSURA



H1



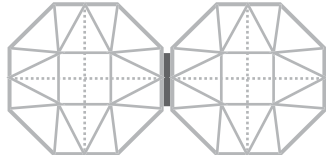

H1 (cm)	€
250	53,00
300	64,00

KIT FOR MODULES CONNECTION
KIT UNIONE MODULI



SIDE LATO (cm)	€
500	127,00
600	141,00





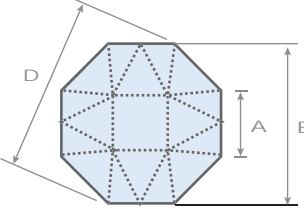







A (cm)	H1 (cm)	€	H2 (cm)	AREA (sqm) (mq)	D (cm)	E (cm)
500	250	24837,00	280	120,0	1305	1205
	300	25079,00				
600	250	27348,00	330	174,0	1570	1450
	300	27590,00				

OPTIONALS FOR MEETING MODEL
OPTIONALS MODELLO MEETING

FRAME COLOURS
COLORI DELLA STRUTTURA

STANDARD  Ral 9010

OPTIONAL + 7%

 Ral 9005  Ral 1023
 Ral 6005  Ral 5010
 Ral 3002



TOP COVER AND VALANCES
TELO DI COPERTURA E MANTOVANE

STANDARD 

OPTIONAL + 3%
BLACK-OUT
OSCURANTE

OPTIONAL + 3%

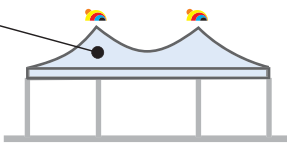
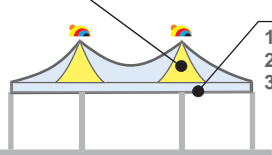



STANDARD



h 30 cm

JUNCTION FILLER
COPRIFESSURA



H1



H1 (cm)	€
250	53,00
300	64,00

KIT FOR MODULES CONNECTION
KIT UNIONE MODULI

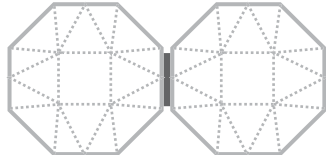

SIDE LATO (cm)	€
500	127,00
600	141,00



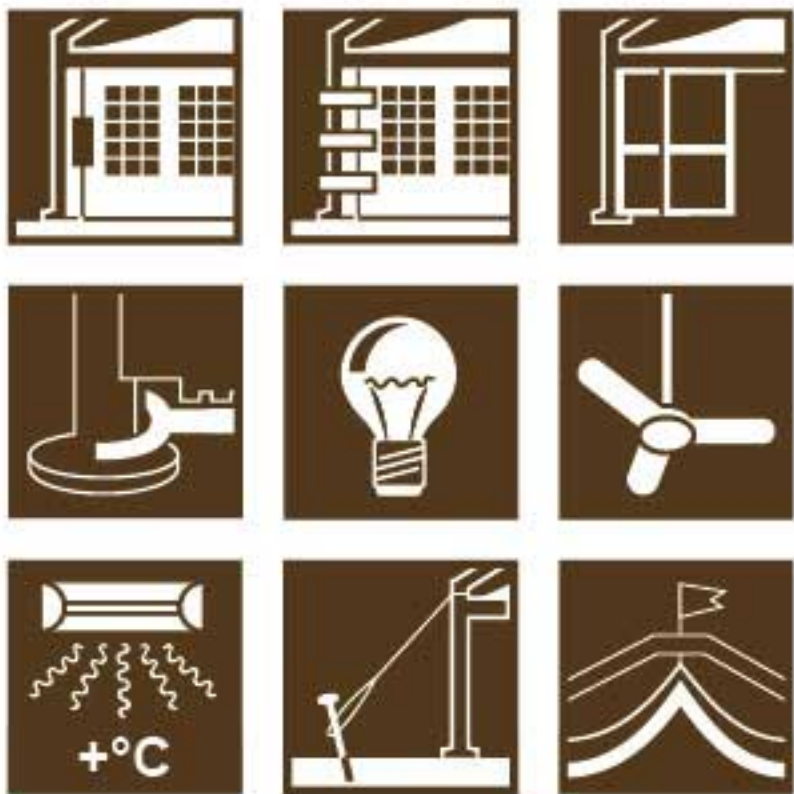

OPTIONALS
ACCESSORI





“CLACK” MODEL: PVC SLIDING SIDE CLOSING
 CHIUSURA SCORREVOLE MODELLO “CLACK” IN TELO PVC



“CLACK” CLOSING FOR THE NEW GENERATION TENTS
 CHIUSURA “CLACK” PER GAZEBO DI NUOVA
 GENERAZIONE

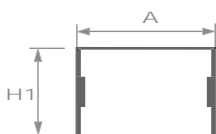

PLAIN WALL
STANDARD

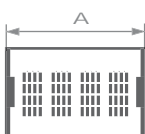

WINDOWS
WALL
FINESTRATA

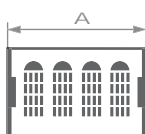

ARCHED WINDOWS
WALL
FINESTRATA
AD ARCO



ALUMINIUM
GROUND GUIDE
GUIDA A TERRA
IN ALLUMINIO

A (cm)	H1 (cm)	€	€	€	€
300	250	328,00	389,00	421,00	103,00
	300	374,00	445,00	481,00	
350	250	359,00	429,00	464,00	113,00
	300	412,00	492,00	532,00	
400	250	379,00	455,00	492,00	124,00
	300	437,00	522,00	565,00	
500	250	431,00	520,00	564,00	142,00
	300	498,00	600,00	651,00	
600	250	496,00	600,00	652,00	160,00
	300	573,00	693,00	754,00	
650	250	538,00	654,00	710,00	178,00
	300	623,00	757,00	824,00	

MIDDLE POLE FOR:
MONTANTE
INTERMEDIO PER:



OTHER DIMENSIONS
ALTRE DIMENSIONI

A (cm)	NOTES FOR : NOTE PER :	Leader MULTI Dynamic MULTI	A (cm)	NOTES FOR : NOTE PER :	Elite Elite IN
700	n. 2 side walls 350 cm + n. 1 junction filler n. 2 pareti da cm. 350 + n. 1 coprifessura		800	n. 2 side walls 400 cm + n. 1 middle pole n. 2 pareti da cm. 400 + n. 1 montante intermedio	
800	n. 2 side walls 400 cm + n. 1 junction filler n. 2 pareti da cm. 400 + n. 1 coprifessura				
1000	n. 2 side walls 500 cm + n. 1 junction filler n. 2 pareti da cm. 500 + n. 1 coprifessura				
1200	n. 3 side walls 400 cm + n. 2 junction filler n. 3 pareti da cm. 400 + n. 2 coprifessura		1000	n. 2 side walls 500 cm n. 2 pareti da cm. 500	
1500	n. 3 side walls 500 cm + n. 2 junction filler n. 3 pareti da cm. 500 + n. 2 coprifessura		1200	n. 2 side walls 600 cm n. 2 pareti da cm. 600	
1800	n. 3 side walls 600 cm + n. 2 junction filler n. 3 pareti da cm. 600 + n. 2 coprifessura		1300	n. 2 side walls 650 cm n. 2 pareti da cm. 650	

H1 (cm)	€
250	375,00
300	410,00

OPTIONALS



"STRAPS" CLOSING FOR THE BASIC RANGE OF TENT
 CHIUSURA "CINGHIETTA" PER GAZEBO GAMMA BASE

SILVER

Summer 4

FESTIVAL

A (cm)	H1 (cm)	€	€	€	€						
300	250	248,00	311,00	340,00	103,00						
400	250	312,00	391,00	429,00	124,00						
	300	378,00	473,00	520,00							
500	250	365,00	456,00	502,00	142,00						
	300	440,00	549,00	605,00							
600	250	418,00	520,00	573,00	160,00						
	300	502,00	629,00	691,00							
OTHER DIMENSIONS ALTRE DIMENSIONI											
A (cm)	NOTES FOR: NOTE PER:	<p>TELESCOPIC POLE KIT FOR: KIT MONTANTE TELESCOPICO PER:</p> <p>FESTIVAL</p> <table border="1"> <thead> <tr> <th>H1 (cm)</th> <th>€</th> </tr> </thead> <tbody> <tr> <td>250</td> <td>108,00</td> </tr> <tr> <td>300</td> <td>117,00</td> </tr> </tbody> </table>				H1 (cm)	€	250	108,00	300	117,00
H1 (cm)	€										
250	108,00										
300	117,00										
800	n. 2 side walls 400 cm + n. 1 telescopic pole kit n. 2 pareti da cm. 400 + n. 1 kit montante telescopico										
1000	n. 2 side walls 500 cm n. 2 pareti da cm. 500										
1200	n. 2 side walls 600 cm n. 2 pareti da cm. 600										

OPTIONALS



“ERMETICA” MODEL: RIGID SLIDING SIDE CLOSING

CHIUSURA SCORREVOLE RIGIDA MODELLO “ERMETICA”

“ERMETICA” RIGID SLIDING SIDE CLOSING

CHIUSURA PERIMETRALE RIGIDA “ERMETICA”

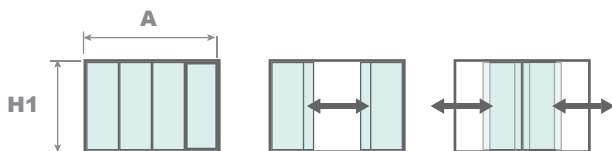

FRAME: made of aluminium powder coated (white colour, ral 9010).
SLIDING PANELS: made of safety glass or polycarbonate 10 mm.
TELAIO: in alluminio ral 9010.
PANNELLI:
 in vetro 3+3 stratificato o polycarbonato alveolare mm.10.

A (cm)	H1 (cm)	€	A (cm)	H1 (cm)	€
300	250	2310,00	430	250	2742,00
	300	2532,00		300	3004,00
350	250	2497,00	500	250	2943,00
	300	2686,00		300	3234,00
400	250	2571,00	600	250	3142,00
	300	2813,00		300	3450,00

FOR DIFFERENT TYPE OF PANEL: PER ALTRI TIPI DI PANNELLO:



STANDARD Ral 9010

OPTIONAL+7%

- Ral 9005
- Ral 1023
- Ral 6005
- Ral 5010
- Ral 3002

OTHER DIMENSIONS

ALTRE DIMENSIONI

A (cm)	NOTES FOR: NOTE PER:	Leader MULTI	Dynamic MULTI	A (cm)	NOTES FOR: NOTE PER:	Elite Elite Ln	A (cm)	NOTES FOR: NOTE PER:	FESTIVAL
700	n. 2 side walls 350 cm n. 2 pareti da cm. 350	800	800	800	n. 2 side walls 400 cm + n. 1 middle pole n. 2 pareti da cm. 400 + n. 1 montante intermedio	800	800	n. 2 side walls 400 cm + n. 1 telescopic pole kit n. 2 pareti da cm. 400 + n. 1 montante telescopico	
800	n. 2 side walls 400 cm n. 2 pareti da cm. 400				n. 2 side walls 500 cm n. 2 pareti da cm. 500			n. 2 side walls 500 cm n. 2 pareti da cm. 500	
1000	n. 3 side walls 400 cm n. 3 pareti da cm. 400	1300	1300	1300	n. 2 side walls 600 cm n. 2 pareti da cm. 600	1300	1300	n. 2 side walls 600 cm n. 2 pareti da cm. 600	
1200	n. 3 side walls 500 cm n. 3 pareti da cm. 500				n. 3 side walls 430 cm + n. 1 middle pole n. 3 pareti da cm. 430 + n. 1 montante intermedio				
1500	n. 3 side walls 600 cm n. 3 pareti da cm. 600								
1800									

MIDDLE POLE
MONTANTE
INTERMEDIO



H1 (cm)	€
250	375,00
300	410,00

TELESCOPIC POLE KIT FOR: MONTANTE TELESCOPICO PER:

FESTIVAL

H1 (cm)	€
250	108,00
300	117,00

OPENING DOOR
ANTA BATTENTE



€

ON REQUEST
A PREVENTIVO

OPTIONALS

"CLACK" MODEL: PVC SLIDING SIDE CLOSING
 CHIUSURA SCORREVOLE MODELLO "CLACK" IN TELO PVC



"CLACK" CLOSING FOR BROOKLYN
 CHIUSURA "CLACK" PER BROOKLYN

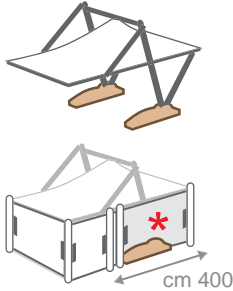

BROOKLYN WITH STANDARD ANCHORING SYSTEM (CONCRETE LOADS)
 BROOKLYN CON ANCORAGGIO STANDARD (BASI IN CEMENTO ARMATO)

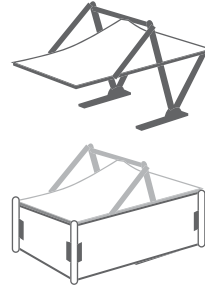

BROOKLYN WITH OPTIONAL ANCHORING SYSTEM (ANCHORING PLATES)
 BROOKLYN CON SISTEMA DI ANCORAGGIO OPZIONALE (PIASTRE)

L (cm)	ALUMINIUM GROUND GUIDE GUIDA A TERRA IN ALLUMINIO			* SIDE WALL PROPERLY SHAPED PARETE SAGOMATA cm 400	ALUMINIUM GROUND GUIDE GUIDA A TERRA IN ALLUMINIO	L (cm)	ALUMINIUM GROUND GUIDE GUIDA A TERRA IN ALLUMINIO		
	PLAIN WALL STANDARD	WINDOWS WALL FINISTRATA	€				PLAIN WALL STANDARD	WINDOWS WALL FINISTRATA	€
100	227,00	264,00	66,00	 Plain wall Standard € each cad. 425,00	 Windows wall Finestrata € each cad. 511,00	100	227,00	264,00	66,00
200	273,00	322,00	88,00			200	273,00	322,00	88,00
300	328,00	389,00	103,00			300	328,00	389,00	103,00
350	359,00	429,00	113,00			350	359,00	429,00	113,00
400	379,00	455,00	124,00			400	379,00	455,00	124,00
500	431,00	520,00	142,00			500	431,00	520,00	142,00
600	496,00	600,00	160,00			600	496,00	600,00	160,00
700	n. 2 side walls 350 cm + n. 1 curtain supporting pole n. 2 pareti da cm. 350 + n. 1 montante di sostegno			700	n. 2 side walls 350 cm + n. 1 curtain supporting pole n. 2 pareti da cm. 350 + n. 1 montante di sostegno				
800	n. 2 side walls 400 cm + n. 1 curtain supporting pole n. 2 pareti da cm. 400 + n. 1 montante di sostegno			800	n. 2 side walls 400 cm + n. 1 curtain supporting pole n. 2 pareti da cm. 400 + n. 1 montante di sostegno				

CURTAIN SUPPORTING POLE MONTANTI DI SOSTEGNO

€ each cad.
 133,00

CURTAIN SUPPORTING POLE MONTANTI DI SOSTEGNO

€ each cad.
 133,00

OPTIONALS



LIGHTING SYSTEM
SISTEMI DI ILLUMINAZIONE

ALUMINIUM ELECTRIC BAR
ASTA ELETTTRIFICATA IN ALLUMINIO

HALOGEN LIGHT
FARETTI ALOGENI

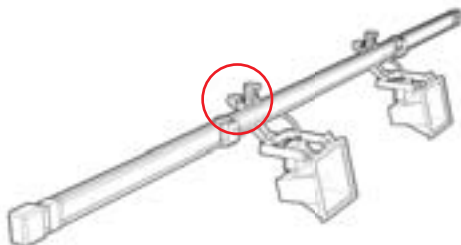

€ each
cad.

230,00

NEON LIGHT
PLAFONIERA AL NEON

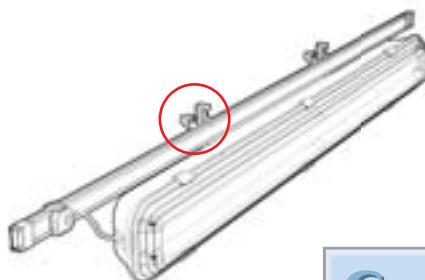

€ each
cad.

230,00

LIGHT CONTROL
COMANDO LUCI



€ each
cad.

239,00

CONNECTION
CABLE
CAVO DI
COLLEGAMENTO



LENGTH LUNGH. (cm)	€ each cad.	LENGTH LUNGH. (cm)	€ each cad.
400	88,00	1400	116,00
800	98,00	1800	127,00

LOW CONSUMPTION LAMPS
LAMPADIE A BASSO CONSUMO



€ each
cad.

306,00

LIGHT CONTROL
COMANDO LUCI



€ each
cad.

245,00

CONNECTION CABLE
CAVO DI COLLEGAMENTO



LENGTH LUNGH. (cm)	€ each cad.
600	87,00

OPTIONAL
ADDITIONAL CABLE
CAVO AGGIUNTIVO

€ /ml **2,00**

OPTIONALS

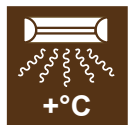

INFRARED RAYS HEATING
RISCALDATORE A RAGGI INFRAROSSI

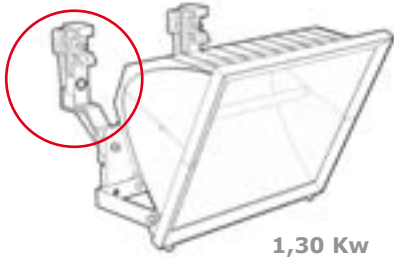

1,30 Kw

€ each
cad.

266,00

INFRARED RAYS HEATING
RISCALDATORE A RAGGI INFRAROSSI

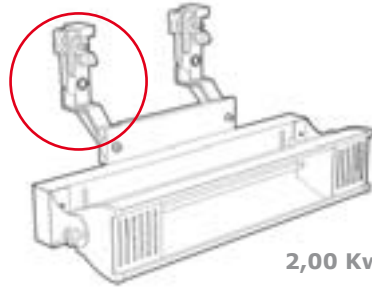

2,00 Kw

€ each
cad.

430,00



= **SLIDE-IN TYPE FASTENING SYSTEM**
= **SISTEMA AD AGGANCIAMENTO RAPIDO**

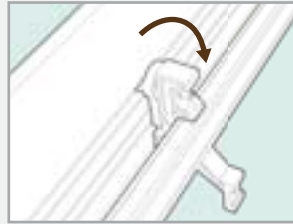

REFRESHING SYSTEM
SISTEMA DI VENTILAZIONE



OPTIONALS

THREE-BLADES FAN WITH CONTROL
VENTILATORE A TRE PALE CON COMANDO

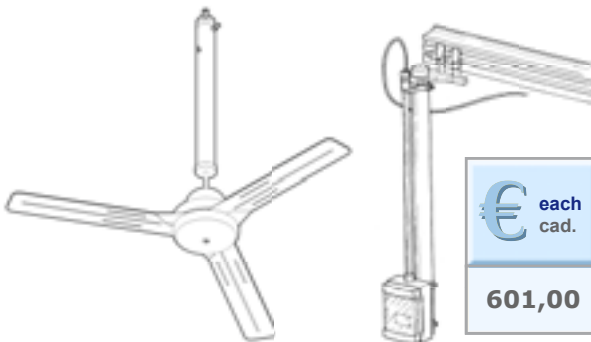

€ each
cad.

601,00

THREE-BLADES FAN WITH LAMP AND CONTROL
VENTILATORE A TRE PALE CON LUCE E COMANDO

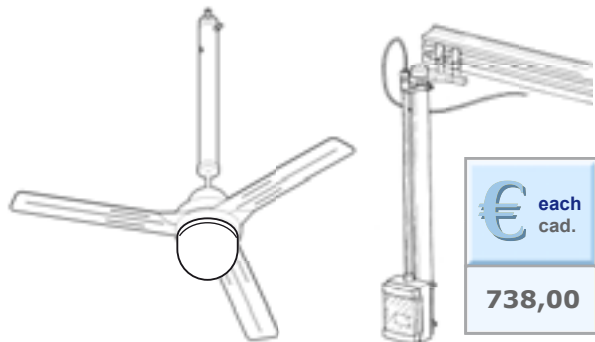

€ each
cad.

738,00



ANCHORING TO THE GROUND

ANCORAGGIO AL SUOLO

SCREW PEG - TYPE A PICCHETTO AD ELICA - TIPO A



€ each
cad.

16,00

Cm. 80 long for sandy ground
Picchetto per terreni sabbiosi
Lungo cm. 80.

T-SHAPED PEG - TYPE B PICCHETTO A "T" - TIPO B



€ each
cad.

16,00

Cm. 80 long for hard ground
Picchetto per terreni compatti
lungo cm. 80.

ROUND PEG TYPE - TYPE C PICCHETTO TONDO - TIPO C



€ each
cad.

16,00

Cm. 35 long
For asphalt
Picchetto
Per asfalto
Lungo cm. 35.

FLOWER BOX IN CONCRETE FIORIERA IN CEMENTO



€ each
cad.

157,00

Weight: kg. 200
Peso: kg. 200

CONCRETE LOAD ZAVORRA IN CEMENTO



€ each
cad.

288,00

Weight: kg. 200
Peso: kg. 200

SAFETY STRAP EQUIPPED WITH RATCHET CINGHIA DI SICUREZZA

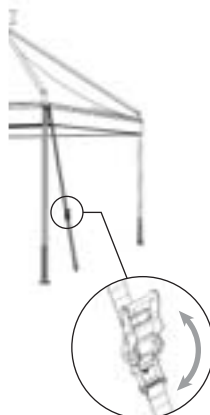

€ each
cad.

18,00

With ratchet
Completa di
Cricchetto



FABRIC SPECIFICATIONS

the linings are manufactured from 100 % non-flammable polyester fibre for maximum durability and easy care. Lining Fabrics have a soft finish with a beautiful silky sheen that resist hard creasing. Standard colours: White and Champagne.

COMPOSIZIONE:

i controsoffitti sono realizzati in 100% fibra di poliestere non infiammabile e sono corredati di garanzia di durata. I tessuti sono ingualcibili, caratterizzati da morbida finitura con un bell'effetto seta e facile manutenzione. Colore standard: disponibile bianco e champagne.

SQUARE AREA AREA QUADRATA		
A=B (cm)	NOTES NOTE	€
300	n. 1 peak n. 1 cupola	655,00
400	n. 1 peak n. 1 cupola	881,00
500	n. 1 peak n. 1 cupola	1287,00
600	n. 1 peak n. 1 cupola	1585,00
700	n. 4 peaks n. 4 cupole	2190,00
800	n. 4 peaks n. 4 cupole	2310,00
1000	n. 4 peaks n. 4 cupole	3419,00
1200	n. 4 peaks n. 4 cupole	4498,00

RECTANGULAR AREA AREA RETTANGOLARE							
A (cm)	B (cm)	NOTES NOTE	€	A (cm)	B (cm)	NOTES NOTE	€
300	400	n. 1 peak n. 1 cupola	815,00	400	1200	n. 3 peaks n. 3 cupole	2543,00
300	500	n. 1 peak n. 1 cupola	850,00	500	600	n. 1 peak n. 1 cupola	1375,00
300	600	n. 1 peak n. 1 cupola	987,00	500	1000	n. 2 peaks n. 2 cupole	2028,00
300	600	n. 2 peaks n. 2 cupole	1121,00	500	1500	n. 3 peaks n. 3 cupole	3746,00
300	900	n. 3 peaks n. 3 cupole	1892,00	600	1200	n. 2 peaks n. 2 cupole	2572,00
400	500	n. 1 peak n. 1 cupola	1054,00	600	1800	n. 3 peaks n. 3 cupole	4612,00
400	600	n. 1 peak n. 1 cupola	1301,00				
400	800	n. 2 peaks n. 2 cupole	1469,00				

HEXAGONAL AREA AREA ESAGONALE			
A (cm)	€	A (cm)	€
300	1424,00	500	2867,00
400	2057,00		

OCTAGONAL AREA AREA OTTAGONALE					
A (cm)	NOTES NOTE	€	A (cm)	NOTES NOTE	€
300	n. 1 peak n. 1 cupola	2130,00	500	n. 4 peaks n. 4 cupole	4899,00
400	n. 1 peak n. 1 cupola	3399,00	600	n. 4 peaks n. 4 cupole	6501,00



**AUXILIARY OPTIONALS FOR INSTALLATION
AND STORAGE**

**ACCESSORI AUSILIARI D'INSTALLAZIONE E
STOCCAGGIO**

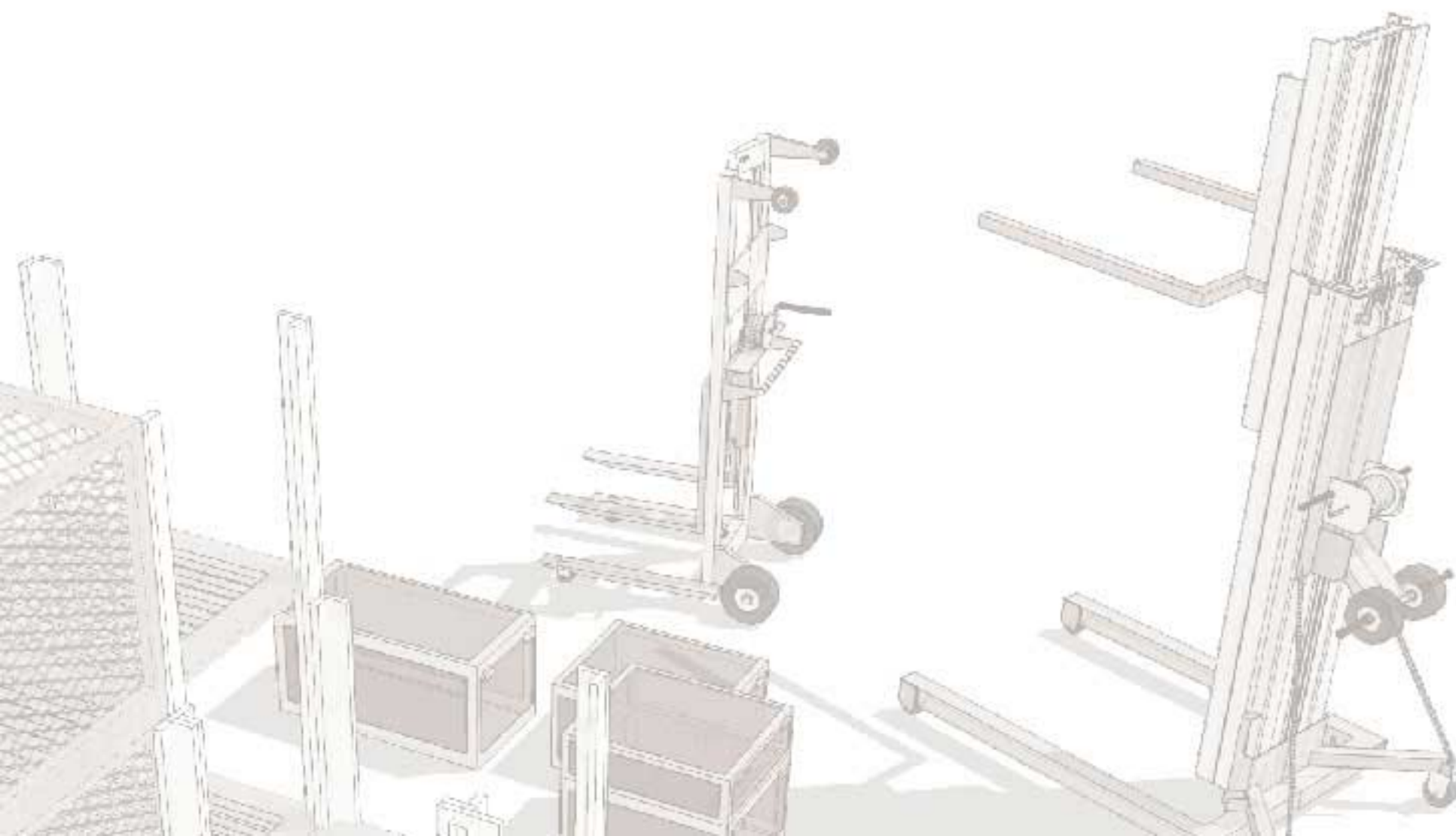



CERTIFIED LIFTING HOISTS
CARRELLI DI SOLLEVAMENTO OMOLOGATI

MODELS MODELLI		
LIFT	SLA 10	SLA 15
<p>TENT PASS HEIGHT= 250 cm ALTEZZA UTILE GAZEBO= 250 cm</p>	<p>TENT PASS HEIGHT= 250 cm ALTEZZA UTILE GAZEBO= 250 cm</p>	<p>TENT PASS HEIGHT= 300 cm ALTEZZA UTILE GAZEBO= 300 cm</p>
<p>SILVER</p>	<p>Leader 6 Dynamic 6</p>	<p>Leader 6 Dynamic 6</p>
<p>Summer 4</p>	<p>Leader 8 Dynamic 8</p>	<p>Leader 8 Dynamic 8</p>
<p>Leader 4</p>	<p>Leader MULTI Dynamic MULTI</p>	<p>Leader MULTI Dynamic MULTI</p>
<p>Dynamic 4</p>	<p>FESTIVAL</p> <p><i>Elite</i> <i>Elite Ln</i> </p>	<p>FESTIVAL MEETING </p> <p><i>Elite</i> <i>Elite Ln</i> </p>
<p>H max = 300 cm</p>	<p>H max = 300 cm</p>	<p>H max = 450 cm</p>
<p>Kg max. = 159 Kg</p>	<p>Kg max. = 454 Kg</p>	<p>Kg max. = 363 Kg</p>
<p>€ each cad. 2682,00</p>	<p>€ each cad. 3836,00</p>	<p>€ each cad. 4547,00</p>
<p>LIFTING HOIST'S WEIGHT PESO DEL SOLLEVATORE</p>		
68 Kg	118 Kg	144 Kg



“RACK” CONTAINERS
CONTENITORI “RACK”

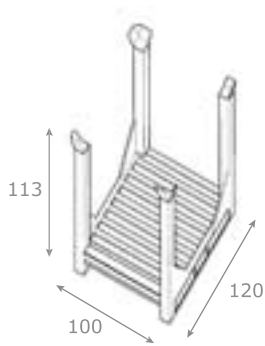

GREY
GRIGIO
RAL 7000

€ each
cad.

436,00

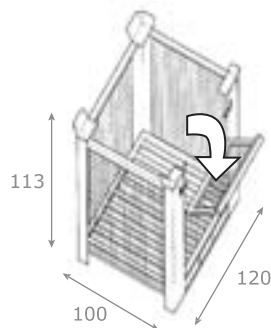

GREY
GRIGIO
RAL 7000

€ each
cad.

383,00

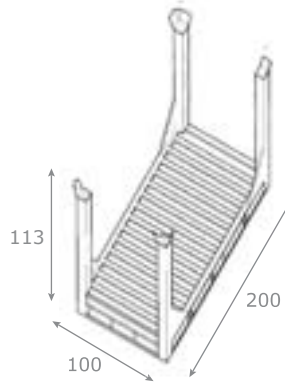

GREY
GRIGIO
RAL 7000

€ each
cad.

595,00

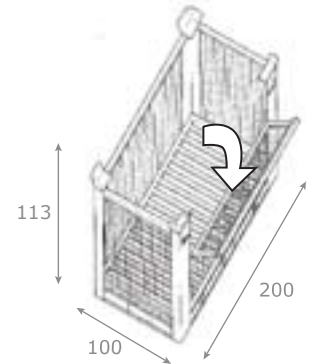

GREY
GRIGIO
RAL 7000

€ each
cad.

750,00